

8" HAND CUP FOR FLAT SURFACES

MODEL: N4950
STOCK: 91500

A standard tool in the glass industry for over 50 years!
Long-term durability and outstanding reliability.

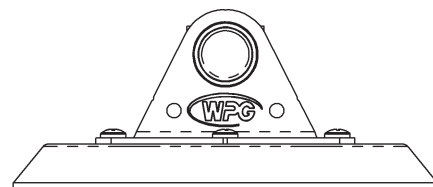
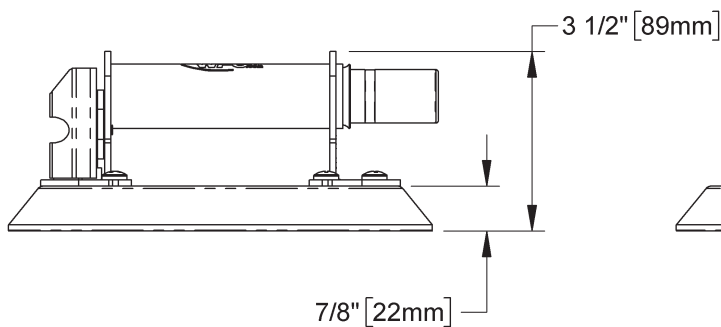
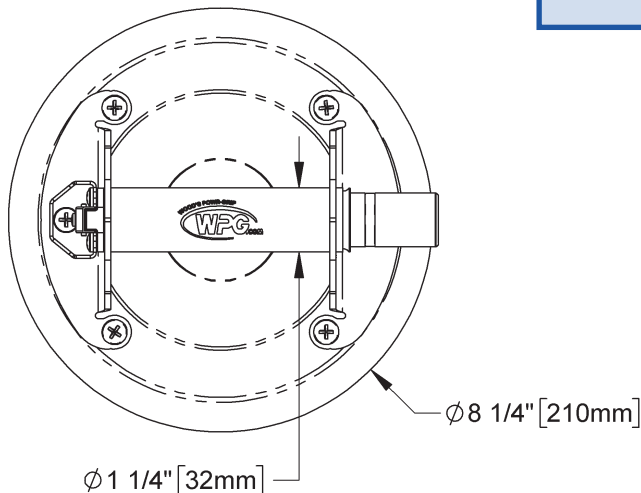
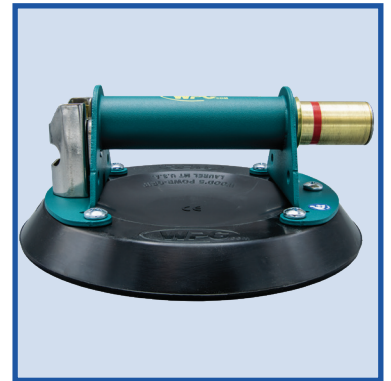

Maximum Load Capacity	125 lbs [57 kg]
Features	Fast attach and release Red-line indicator warns user of any significant vacuum loss Eligible for WPG Hand Cup Exchange Program Supplied with protective carrying case
Surface Texture	Smooth
Material Porosity	Nonporous
Surface Curvature	Flat
Maximum Elevation	5,000 ft [1,524 m]
Material and Ambient Temperature Range	10° F [-12° C] – 120° F [49° C]
Ideal Uses	Glass and other smooth, nonporous flat surfaces
Nominal Pad Diameter	8" [20 cm]
Pad Model	VPFS8L
Rubber Type	Standard
Handle Type	Metal
Based on product information at time of publication. Environmental conditions can affect product performance and longevity; consult the product instructions on WPG.com or contact a Technical Sales Representative for more information.	

