

- To ensure correct installation, be sure to read these instructions carefully before you install the system.
- Please properly dispose of the packing materials and residual materials in accordance with legal provisions.

Instruction Manual Installation Manual

Pull Down Unit W300/W450
Model No. DVTWBH030 (045) -E

**To Installer : Make sure to pass this integrated Precautions for Use to the customer after installation.
Make sure to pass this manual to customers after installation.**

Safety Precautions

Be sure to observe the following precautions.

To reduce the risk of injury, loss of life, electric shock, fire, malfunction, and damage to equipment or property, always observe the following safety precautions.

Explanation of symbols

- The following symbols are used to classify and describe the level of hazard, injury, and property damage caused when the denotation is disregarded and improper use is performed.
- The following symbols are used to classify and describe the type of instructions to be observed.



 **WARNING** Denotes a potential hazard that could result in serious injury or death.

 **CAUTION** Denotes a hazard that could result in minor injury.

 This symbol is used to alert users to a specific operating procedure that must not be performed.

 This symbol is used to alert users to a specific operating procedure that must be followed in order to operate the unit safely.

WARNING





 Disassembly is prohibited.	<ul style="list-style-type: none"> ● Do not attempt to disassemble, repair, or modify the product. This may lead to the product falling down, causing personal injuries. 	 Be sure to observe.	<ul style="list-style-type: none"> ● You must use the designated screws. Failure to do so may cause the rack to fall down, causing personal injuries.
 Be sure to observe.	<ul style="list-style-type: none"> ● When installing on the wall, use the designated stays. Failure to do so may cause the rack to fall down, causing personal injuries. ● Wall mounting and attachment of the cabinet must be securely tightened. Failure to do so may cause the rack to fall down, causing personal injuries. 		<ul style="list-style-type: none"> ● When using screws during installation, they must be hand tightened with a screwdriver. Do not over tighten, as this may cause damages to the screw thread and screw head (stripped screw). Failure to do so may cause the rack to fall down, causing personal injuries.

CAUTION

 Be sure to observe.	<ul style="list-style-type: none"> ● Do not put your finger near any movable parts. This may cause injuries.
--	--

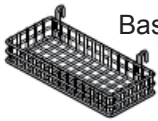
Parts List

(Dimensional unit: mm)

Part	Quantity	Part	Quantity
 Rack	1 set	 Basket	1 set
 Spring		 Hanger	
		Pan head screw $\phi 4 \times 14$ 	
		Flat head screw $\phi 3.9 \times 16$ 	8

Condition for Installation

(Dimensional unit: mm)

- This Product has been designed to maximize the space in a manufactured wall mounted cabinet with the following dimensions (use diagram below)
The appropriate internal dimensions of the cabinet in which the Pull Down Unit will be installed must be ensured.
- Ensure the cabinet where you are attaching the Product is level and plumb.

1 After assembling the cabinet.

Screw the spring into the top and back panels using the 4 4x14 pan head screws.

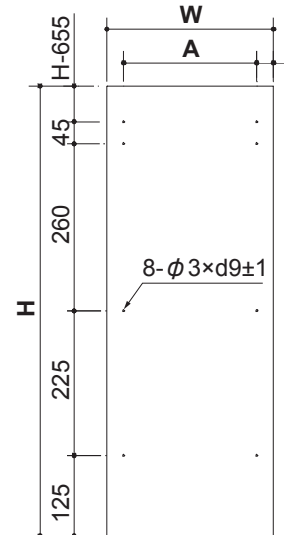
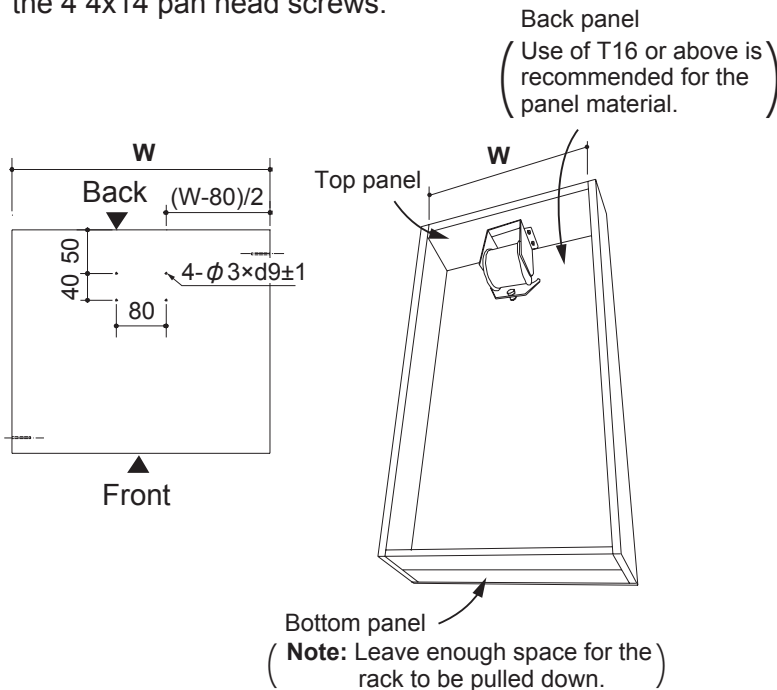

Model	For W450	For W300
A	363	213

Note:

Mounting height of the rack is more than or equal to 684 mm
Mounting width of the rack is more than or equal to 265 mm
Mounting depth of the rack is more than or equal to 135 mm

2 Assembling the rack and connecting the rack to the spring.

- ① Place the rack inside the cabinet and adjust it so that it is in the correct position.

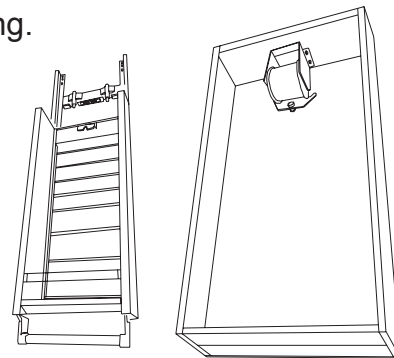

- ② Use screws to fasten the rack with flat head screws then connect the spring and rack together.
- ③ After the spring and rack are fastened together, install the cosmetic front panel to the cabinet.(not included)

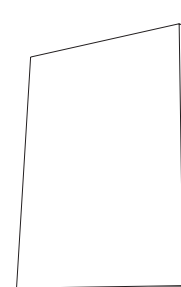
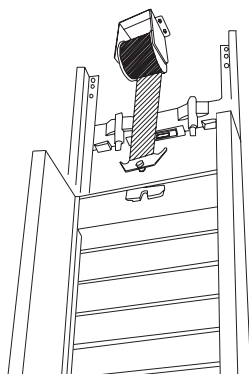

Cosmetic cabinet front panel

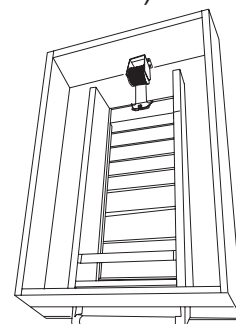

Check after installation

Install the accessories and pull down on the handle to make sure the pull-down rack is working correctly.

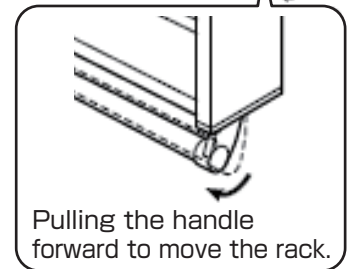
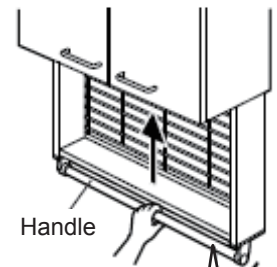
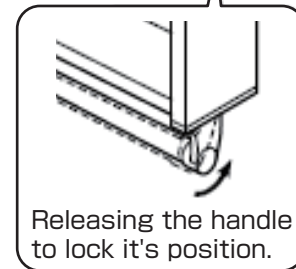
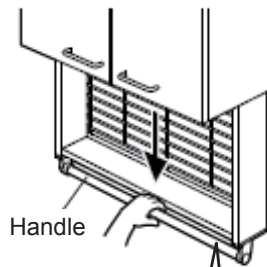
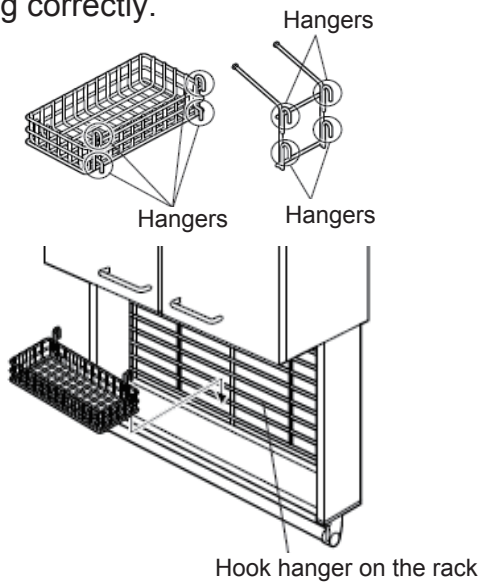

Precautions for use

CAUTION

- Do not hang on or apply excess force to the cabinet, rack or handle.
Doing so could cause the product failure or cause the rack, cabinet or stored objects to fall, resulting in personal injury.

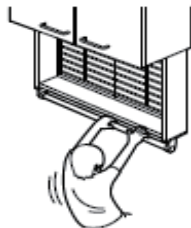

- Do not place moist or wet items in or on the rack as it may cause the rack to rust.

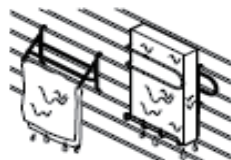

- When pulling up and down the rack, do not touch the side of the rack or any other part of the rack.
Always make sure fingers are kept clear of any part of the rack.
You could get your fingers caught in the moving parts.
Use caution to slowly pull the rack up and down as rapid action may cause the stored objects to fall and injure you.

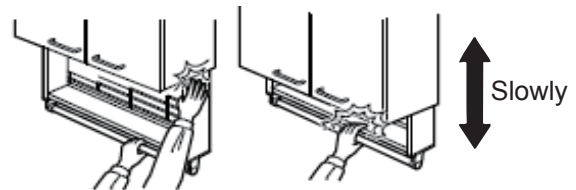

- Weight capacity of the rack.

Model	For W450	For W300
Weight capacity	1.5kg	1.0kg

Cleaning and Care

- When cleaning the unit, wipe with a sponge soaked in diluted dishwashing detergent.
(Avoid using alkaline cleaners or acidic cleaners.)

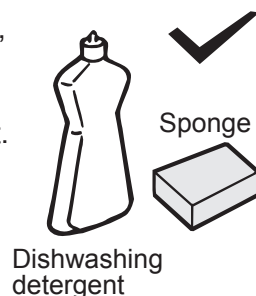

- ※ Do not use any harsh chemicals powder cleansers, paint thinners, or benzine.

If used, the surface of the product might be scratched or degraded, or become discolored.

