

833.89.333 833.89.334
833.89.335 833.89.032

		V			T _A
833.89.333		12 V 24 V	0 – 3000mm 0 – 118.11in	45x12mm / 1.77x0.47in	-20°C – + 45°C -4°F – +113°F
833.89.335					
833.89.334					
833.89.032					

732.28.475

A₁

833.89.334

A₂

833.89.333
833.89.335

A₃

833.89.032

B

+

833.89.331

833.89.332

833.89.330

2x

C

D

F

x

X	
500	833.89.140
1000	833.89.141
2000	833.89.142

[WS157]

i

100 - 240 V~

HDE 18.06.2024

1

833.89.334
5% 100%

833.89.333
833.89.335
30/60/180 sec

833.89.032
Memory OFF → Memory ON

2a

12 mm / 0.47 in

mm / in

Ø 12 / 0.47

45 / 1.77

Ø 12 / 0.47

A₁ / A₂ / A₃

F

?

B

1

2

3

4

732.28.475

[WS157]

HDE 18.06.2024

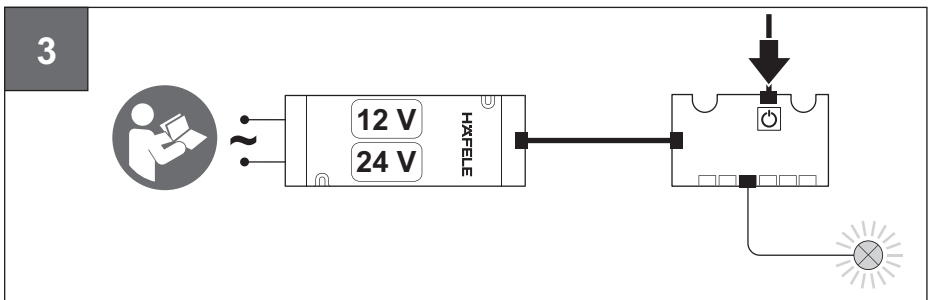
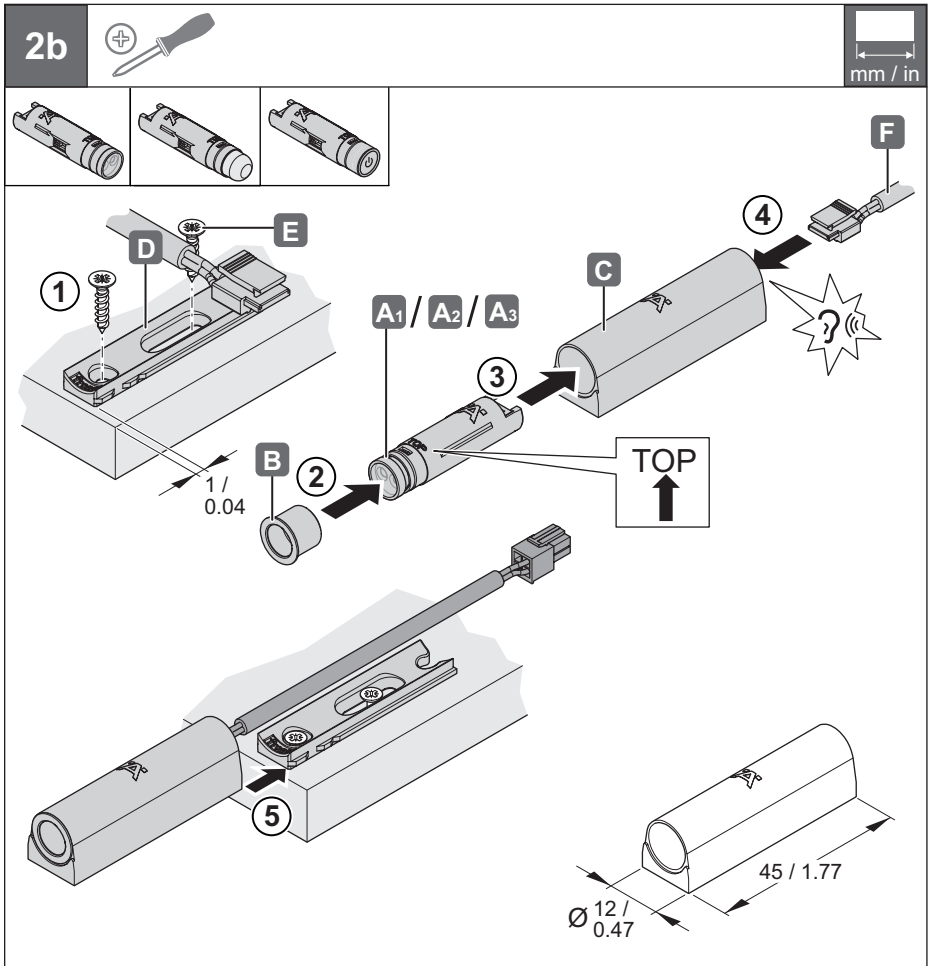

i

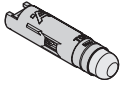

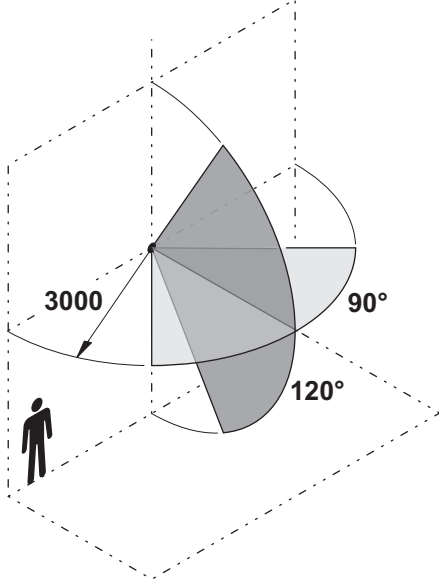

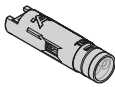

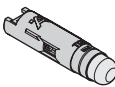

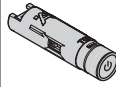

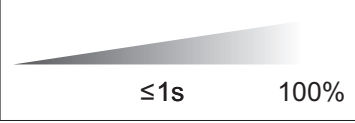

$\leq 1s$ 100%

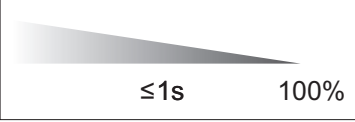

$\leq 1s$ 100%

732.28.475

[WS157]

HDE 18.06.2024